

Pump Model CPS 200-125-290

Speed 2900rpm

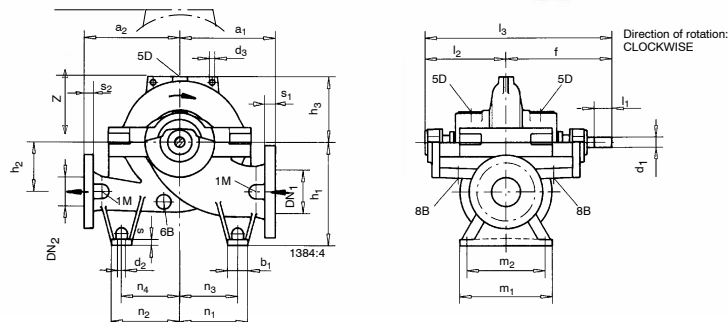
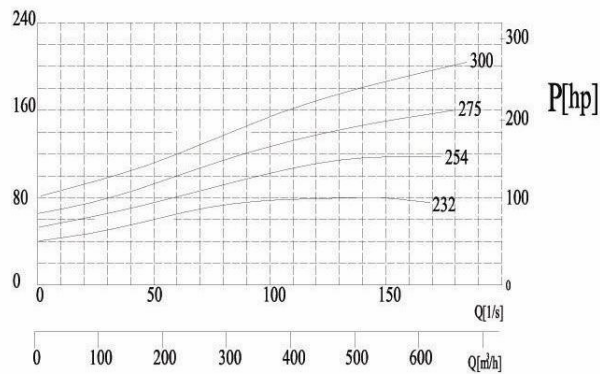
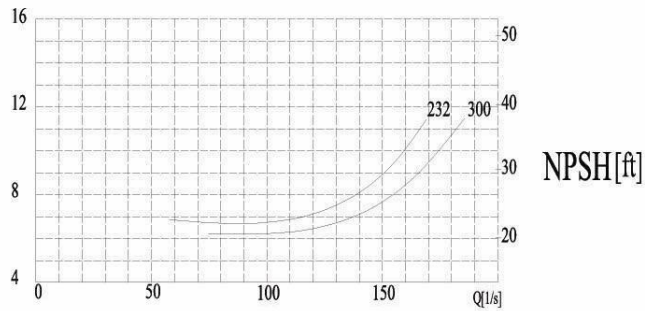
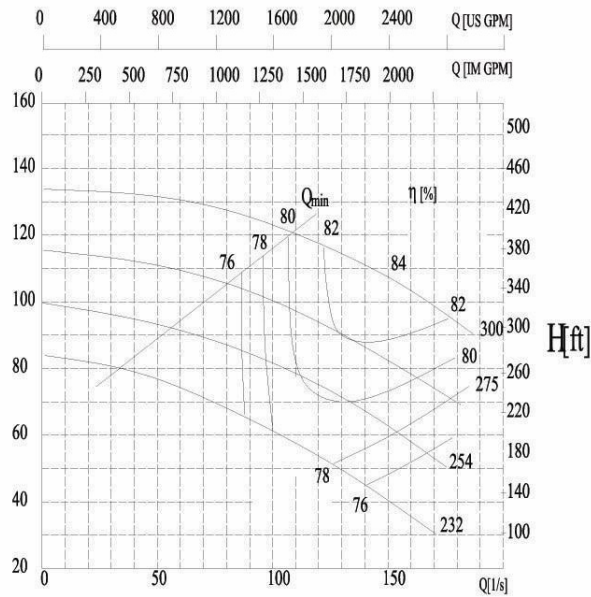

Pump Size	FLANGE DIMENSIONS				PUMP DIMENSIONS									
	DN1	DN2	s1	s2	a1	a2	d3	f	h1	h2	h3	l2	l3	z
CPS 200-125-290	200	125	41	35	370	370	19	515	400	200	230	366	881	460
	FOOT DIMENSIONS						SHAFT			PUMP WEIGHT				
	b1	d2	m1	m2	n1	n2	n3	n4	s	d1	L1	(kg)		
70	18	390	340	260	260	225	225	20	45	100	275			